



# CITADEL 2™ LED COMPONENTS

*Style 1 Flat Board Tray System*

*Style 2 Extruded Board Tray System*

*Style 3 Sheet Metal Board Tray System for Wide Distribution*

*Components for Integration of LED Systems*

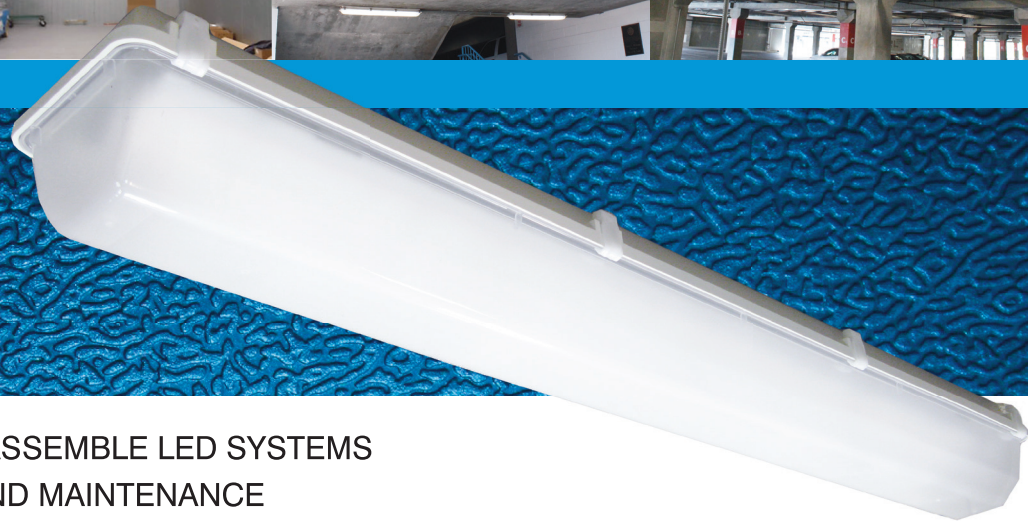
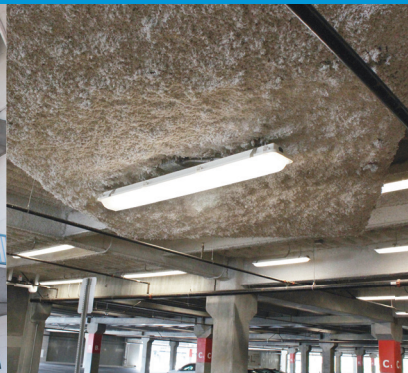

- DESIGNED FOR EASY TO ASSEMBLE LED SYSTEMS
- EASE OF INSTALLATION AND MAINTENANCE
- VISUALLY FAMILIAR LIGHT SOURCING
- MULTIPLE LIGHTING SOLUTIONS
- DesignLights Consortium® QUALIFIED LISTED PRODUCT

**Patent Pending**



On Specified Configurations  
Visit [www.designlights.org/qpl](http://www.designlights.org/qpl) for Details

# Board Tray Hardware

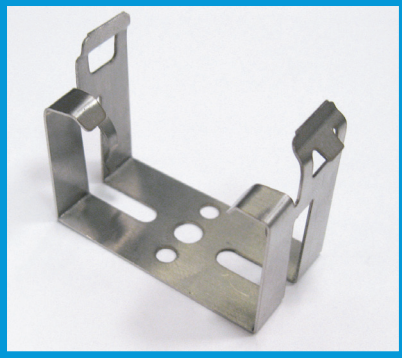

## Wide Retainer Clips

- For Board Trays with Single Center row of LEDs
- 316 Stainless Steel
- **CT-RC-WIDE**



## Traditional CT2 Retainer Clips

- For Board Trays with Two rows of LEDs
- 316 Stainless Steel
- **CT-RC**

**Retainer Clips Easily Installed with CT-SCRW**



## Board Retention Clips

- See Citadel Enclosures Common Components
- **CT-LED-BRC-SM**

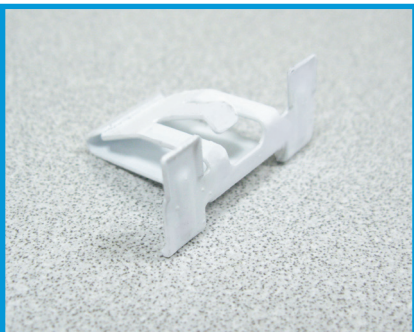

## Board Retention Clips Single Row

- See Citadel Enclosures Common Components
- **CT-LED-BRC-SM-S**



# LED Style 1 Board Tray

- Flat Board Tray Designed For LED Board Placement

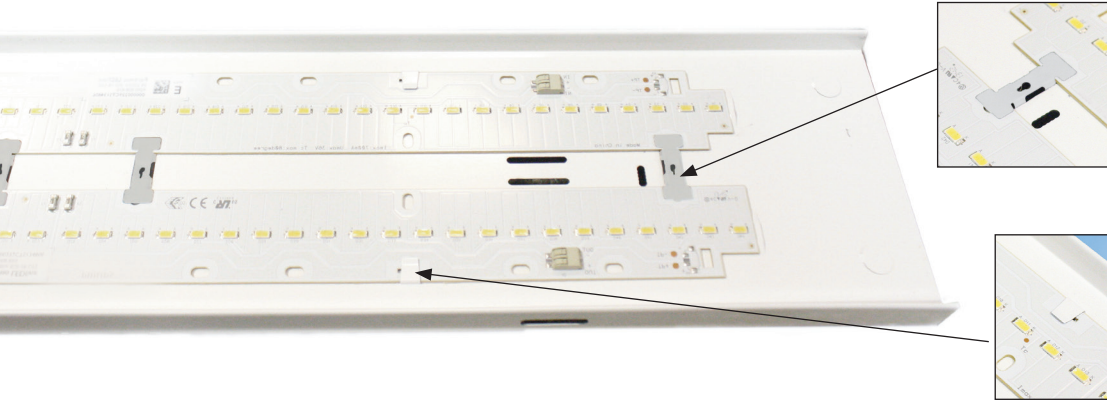

- Board Retention Clips hold boards in position.  
- NO TAPE OR SCREWS

- Lance keeps boards from slipping out of place

## Universal Board Trays

- Single Boardtray for multiple configurations
  - 1 Row or 2 Rows of Linear Zhaga boards
- Board mounting holes 0.110" diameter
  - SLP CT2-LED-SCRW-850
- Ground and driver tray holes 0.140" diameter
  - SLP CT-SCRW-UGT to attached Driver Trays
- 1 or 2 "L" Driver Tray(s) only

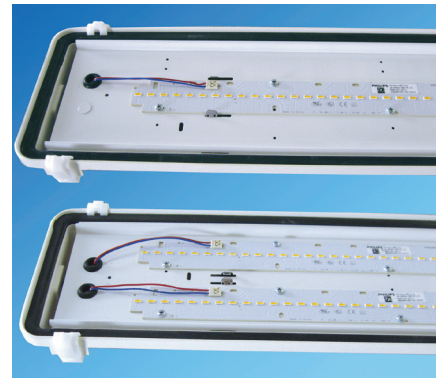

**CT2-LED-BT1-2L2-LZ**  
**CT2-LED-BT1-2L4-LZ**  
**CT2-LED-BT1-2L8-LZ**

# Two Row Board Trays

- Board Trays for Two Rows of LED
- Boards at Typical Board Widths
  - 0.95" & 1.60"
- 2', 4', and 8' Lengths Available
- Custom Designs Available

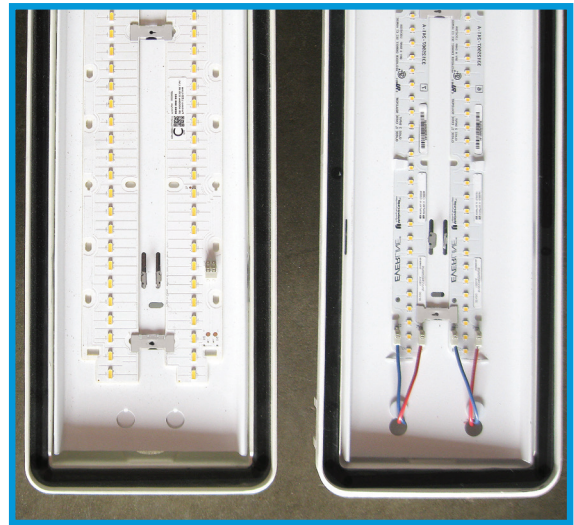

1.60"

0.95"

# Single Center Row

## Wide Center Row of LEDs with Clips

- Wide Board Tray for Single Row of LEDs
- Wide Retainer Clip holds Board Tray in Place
- Lances and Board Retention Clips hold Boards in Place
  - No Tape or Screws Needed
- For Typical Board Widths 0.95" or 1.60"
- 2', 4', and 8' Lengths Available
- Custom Designs Available



1.60"

0.95"

## Narrow Single Center Row Board Tray

- Wide Retainer Clip holds Board Tray in Place
- For Typical Board Widths 1.60" or Less
- Special Board Retention Clip for single row applications



# LED Style 3

## Geartray

- Pre-painted Cold Rolled Steel
- Carries all the electrical gear and keeps separate from the LED Boards
- Installs using traditional Citadel Retainer Clips (CT-RC)
- **CT2-LED-GT3-22-M OR CT2-LED-GT3-24-M**

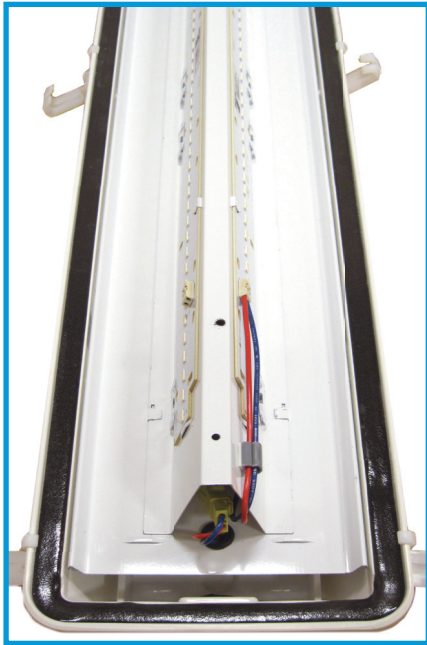
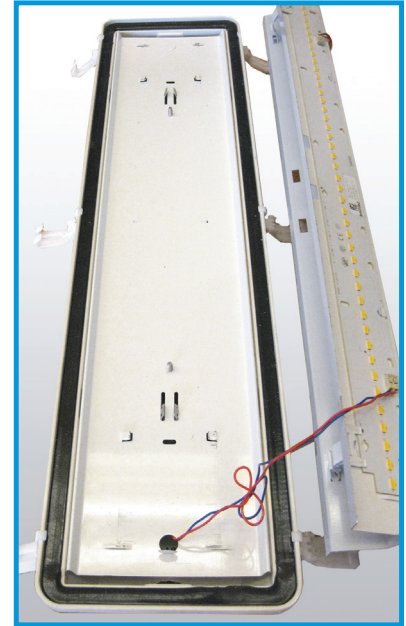

## Board Tray

- Pre-painted Cold Rolled Steel
- Angled design for wide distribution
- 2' and 4' lengths
- For Typical Board widths 1.60"
- Custom Designs Available
- **CT2-LED-BT3-22-M-160 OR CT2-LED-BT3-24-M-160**



Simply snaps into the Geartray Lances

Alignment Ridges keep it centered

- Hinge feature for easy fixture maintenance



# LED Wide Reflector

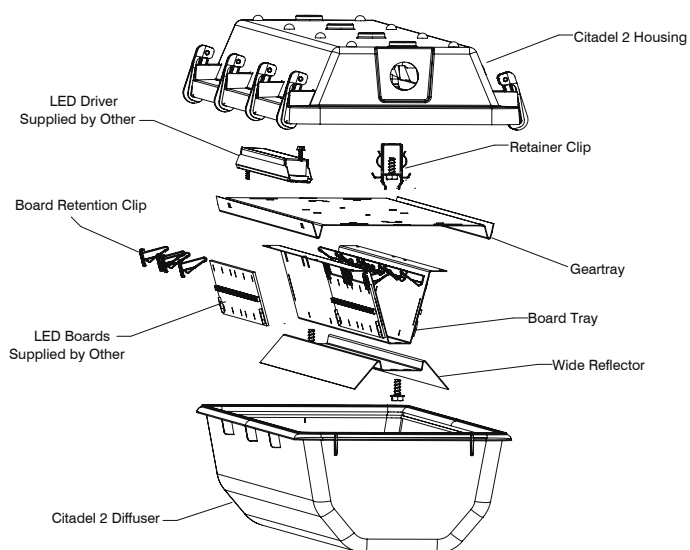

- Reflector creates a wide distribution of LED light
- Installed with CT-SCRW
- Patent Pending
- DLC Parking Garage
- **CT2-LED-RF-2L2-M**  
**OR CT2-LED-RF-2L4-M**



# Certifications

UL

NSF

NEMA 4X

IP65

IP66

IP67

RoHS

PSI 1500

## SLP Guardian Seal

Patented



**UL Listing: File E363909**  
**UL Recognized Components: File E215168**  
**Components Tested and Certified**  
**by NSF International**

## NEMA 4X



Offers 34% more contact between the lens and the gasket. Guardian Seal™ is a unique combination of our Injection Molded lens features and high performance “poured in place” gasket. This provides the most advanced sealing system available.



*On Specified Configurations*  
Visit [www.designlights.org/qpl](http://www.designlights.org/qpl) for Details  
Scan QR Code for  
Complete SLP QPL Listings





SLP LIGHTING  
1400 S. OLD HIGHWAY 141  
FENTON, MO 63026 USA  
PHONE: 800.248.0224 / 636.600.4084  
FAX: 636.600.4108  
SALES@SLPLIGHTING.COM  
WWW.SLPLIGHTING.COM

V08212018