

CITADEL 2 - LED WIDE DISTRIBUTION SERIES

Second generation gasketed enclosure. CITADEL 2 offers more versatility and benefits than any other weatherproof enclosure offered in North America.

FEATURES & BENEFITS:

Housing

- UL 5VA fiberglass (will not melt or burn)
- UL approved for through wiring
- UL f1 rated (suitable for outdoor use exposure to ultraviolet light)
- Meets UL 746 (suitable for exposure and immersion of water)

Board & Ballast/Driver Trays

- Fluorescent sockets or LED boards are attached to a one piece white steel tray
- Tray securely snaps into stainless steel retainer clips, which are installed in housing
- Integral hanger hook allows suspension of the tray during maintenance & installation
- Nylon safety straps attach the tray and retainer clips for safety and easy maintenance
- Ballast/ drivers are either mounted to the backside of the gear/board trays or the inside of the housing on a separate white steel tray

Gasket

- "Poured in place", closed cell polyurethane
- Compression recovery of 95-99%
- Will not support fungal growth

Latches

- CAPTIVE, affixed to the housing therefore will not fall off
- LOCK open thus saving time and money during maintenance and installation
- TAMPER proof, when using screws
- Available in
 - Clear Polycarbonate
 - White POM
 - Marine Grade 316-Stainless Steel

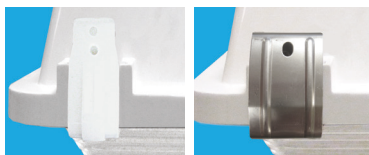

DIMENSIONS:

Available in 2', 4' and 8' lengths

All dimensions are shown in inches unless otherwise noted.

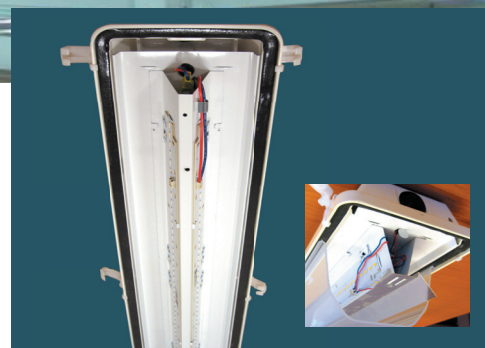
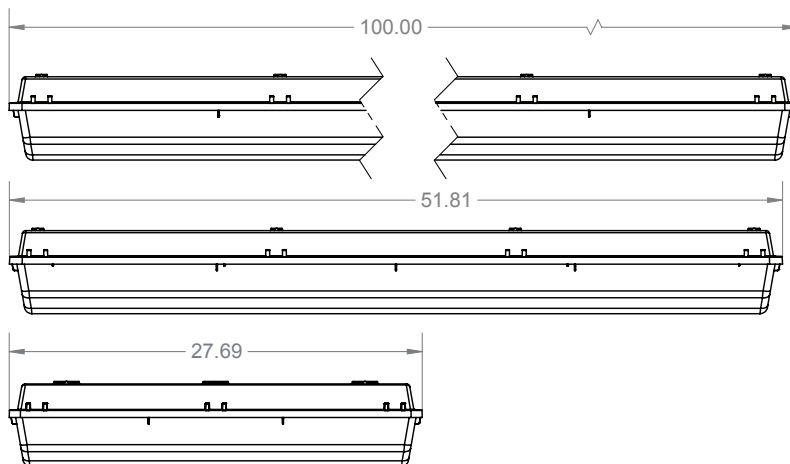
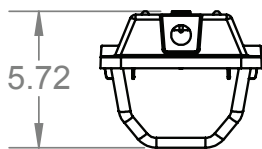

CERTIFICATIONS:



Learn about SLP Certifications at:

www.slplighting.com/SLP/certificatedefinitions.html

CITADEL 2 - LED WIDE DISTRIBUTION

ACCESSORIES & OPTIONS:

Optics:

- All SLP lenses are injection molded and have the Guardian Seal feature
- Available in either Clear or FR50 Frost
 - Acrylic
 - 100% impact modified (similar to DR), non-yellowing
 - Best in areas with UV exposure
 - Clear transmission 93%
 - Frosted transmission 88%

Lens

- Smooth (deep profile)
 - Best for use with reflectors or a wide distribution light distribution



Photometrics Available at: http://www.slplighting.com/SLP/photometrics_enter.html

Installation:

- Fixture can be mounted in various ways direct to the ceiling, junction box, against wall at 45 degrees, pendant (single or dual point), by Gripple cable or chain.

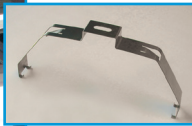

APPLICATIONS:



PARKING GARAGE

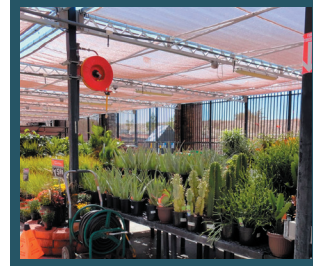

GARDEN CENTERS



STAIRWELLS

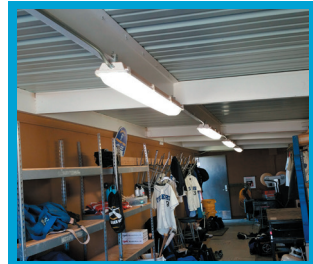

STORAGE



UNDERAWNINGS



FOOD PROCESSING